



# Water Heater Unit



Feel the drive

<b>Thermo Top E Auxiliary Heating</b>	 00 0003
<b>Thermo Top C Auxiliary Heating</b>	 00 0002
<b>Thermo Top P Auxiliary Heating</b>	 00 0104

## Installation Instructions

### Alfa Romeo 159

Gasoline and diesel  
From model year 2006  
For left-hand drive vehicles only



#### WARNING!

Hazard warning:

Incorrect installation or repair of Webasto heating systems may cause a fire or result in the emission of carbon monoxide, which can be fatal. Serious or fatal injuries can be caused as a result.

Specialist company training, technical documentation, specialized tools and equipment are required to install and repair Webasto heating and cooling systems.

NEVER attempt to install or repair Webasto heating or cooling systems if you have not successfully completed the company training and thereby acquired the required technical skills or if you do not have access to the required technical documentation, tools and equipment needed to carry out correct installation and repairs.

ALWAYS follow all Webasto installation and repair instructions and observe all warning instructions.

Webasto does not accept any liability for defects and damage that are attributable to an installation by untrained staff.

## Table of Contents

Validity	2	Thermo Call Option	11
Heater Unit / Installation Kit	3	Preparing the Heater Unit	12
Foreword	3	Preparing the Installation Location	12
General Instructions	3	Assembling the Heater Unit	12
Special Tools	3	Exhaust System	14
Explanatory Notes on the Document	4	Water Connection for Gasoline Engines	16
Preliminary Work	5	Water connection for Diesel Engines	19
Heater Unit Installation Location	5	Combustion Air	22
Preparing the Electrics	6	Fuel Connection	23
Electrical Connection	7	Final Work	27
Automatic air conditioning blower control	8	Operating instructions for the end customer	28
Remote start option	10	Tank extracting device template	29

## Validity

Manufacturer	Model	Type	EG-BE No. / ABE
Alfa Romeo	939	159	e3 * 2001 / 116 * 0212

Engine type	Engine	Power in kW	Engine capacity in cm <sup>3</sup>
939A5000	Gasoline	136	2198
939A2000	Diesel	110	1910

Vehicle and engine types, equipment variants as well as national specifications, which are not listed in these installation instructions, have not been tested. Installation according to these installation instructions may, however, be possible.

The installation location of a time switch and summer / winter switch should be confirmed with the end customer before installation.

## Heater Unit / Installation Kit

Amount	Description	Order No.:
1	Commercial supply of required control	See price list
1	Installation kit for Alfa Romeo 159 Gasoline and diesel	1310979A

### Also required for automatic air conditioning:

Amount	Description	Order No.:
1	IPCU kit	9015473A

### Recommended heater unit for the relevant vehicle class:

Vehicle	Heater unit
Compact car	Thermo Top E
Mid class, station wagon	Thermo Top C
Luxury, van, off-roader	Thermo Top P

Select the heater unit based on the size of the vehicle passenger compartment and the customer's comfort requirements.



## Foreword

These installation instructions apply to vehicles Alfa Romeo 159 with Gasoline and diesel engines – re. validity, see page 2 – from model year and later, assuming technical modifications to the vehicle do not affect installation, any liability claims excluded. – Depending on the vehicle version and equipment, modifications may be necessary during installation with respect to these installation instructions.

However, the stipulations in the "installation instructions" and "operating and maintenance instructions" for the *Thermo Top C/P/E* are to be observed in any event.

The corresponding rules of technology and any information from the vehicle manufacturer should be observed during the installation work.

## General Instructions

Installation should be carried out according to the general, standard rules of technology. Unless specified otherwise, fasten hoses, lines and cable harnesses to original vehicle lines and cable harnesses using cable clips.

Sharp edges should be fitted with edge protectors (split open plastic hose).

Spray unfinished body areas, such as bore holes, with anti-corrosion wax (Tectyl 100K, Order No. 111329).

## Special Tools

- Torque spanner for 2.0 - 10 Nm
- Vise-grip wrench
- Riveting nut tool

**Explanatory Notes on the Document**

To provide you with a quick overview of the individual working steps, you will find an identification mark on the outside top right corner of the page in question.

**Mechanics**

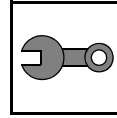

**Electrics**

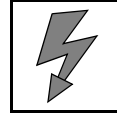

**Water connection**

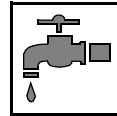

**Fuel connection**

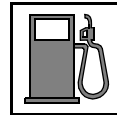

**Exhaust system**

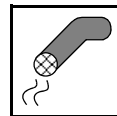

**Combustion air**

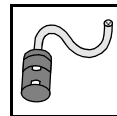

Special features are highlighted using the following symbols:



Specific risk of injury or fatal accidents



Specific risk of damage to components



Specific risk of fire or explosion



Reference to general installation instructions of Webasto components or to the manufacturer's vehicle-specific documents



Reference to a special technical feature

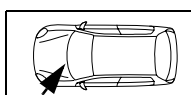
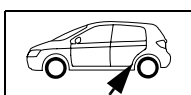

The arrow in the vehicle icon indicates the position on the vehicle and the viewing angle

## Preliminary Work

### WARNING!

- Disconnect the battery.
- Let off pressure in the cooling system.
- Copy the factory number from the original type label to the duplicate type label.
- Remove years that do not apply from the duplicate label.
- Attach the duplicate label (type label) in the appropriate place.
- Completely remove the battery
- Open the tank cap, ventilate the tank.
- Close the tank cap again.
- Remove the left wheel-house panel
- Remove the underride protection
- Remove the underbody panel on the rear right on the tank
- Remove the rear seat bench according to the manufacturer's instructions.
- Open the tank mounting service lid in the middle
- Remove tank mounting according to manufacturer's instructions.
- Remove the footwell cover on the left and right
- Please remove page 28 "Operating instructions for the end customer" and add this to the operating instructions.

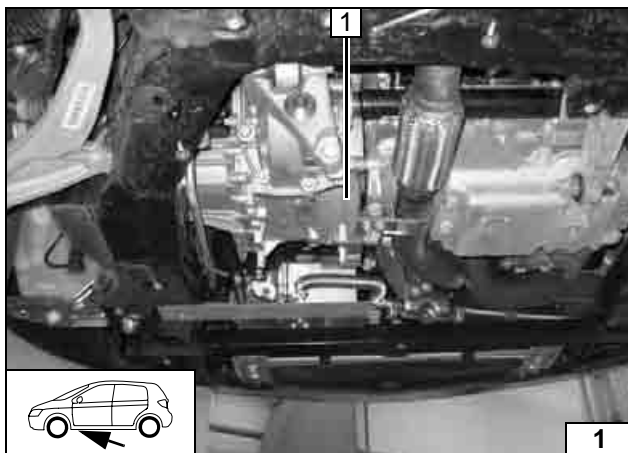

## Heater Unit Installation Location

- 1 Heater unit

Installation  
location

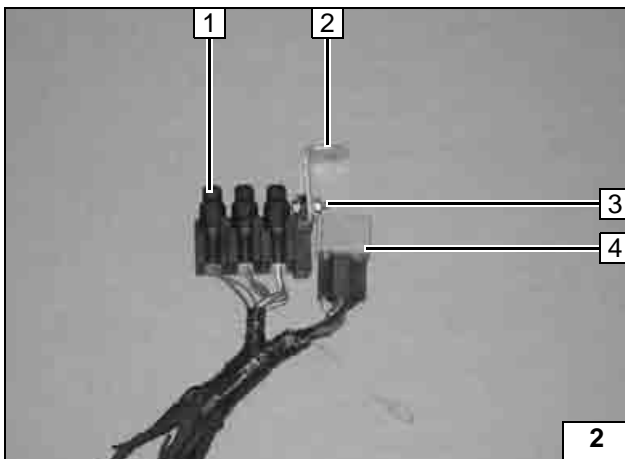
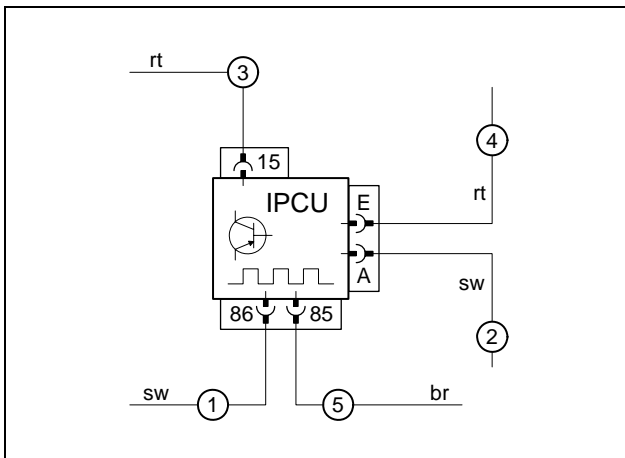
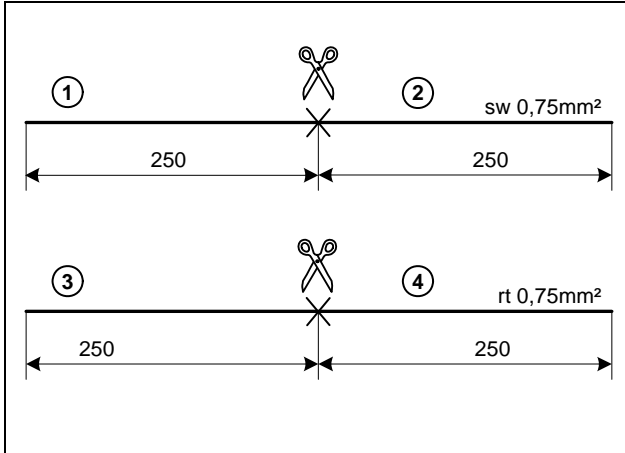

## Preparing the Electrics

### Only for automatic air conditioning

Wire sections 1, 2, 3, 4 will be needed later for connection to the IPCU.

Before preassembling the IPCU, set the following values with the Webasto PC Diagnostic Tool (version 2.07 and higher):

Voltage: 10 V  
 Frequency: 100 Hz  
 Duty-Cycle: 46 %  
 Function: Low-side

Connect the enclosed wire section 5 as well as the prepared wire sections 1, 2, 3, 4 according to the circuit diagram.

### For all vehicles

- 1 Fuse holder
- 2 Angle bracket
- 3 Bolt M5x16, washer, fuse holder angle bracket, flanged nut M5
- 4 K3 relay



Cutting wires into sections



Pre-assembling the IPCU



Pre-assembling the fuse holder



**Electrical Connection**

**Installing the cable harness**

1 Time switch cable harness and blower control in the left wheel house.

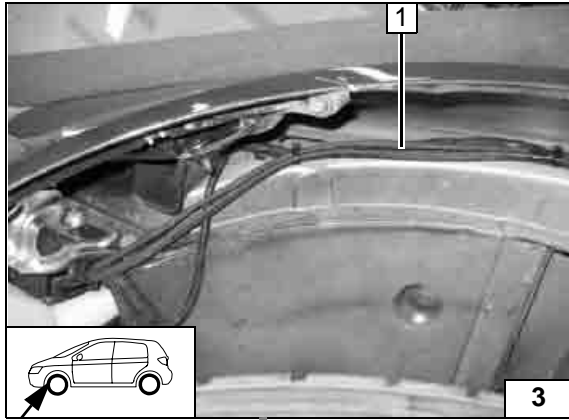

**Time switch / summer / winter switch option**

1 Time switch  
2 Summer / winter switch option

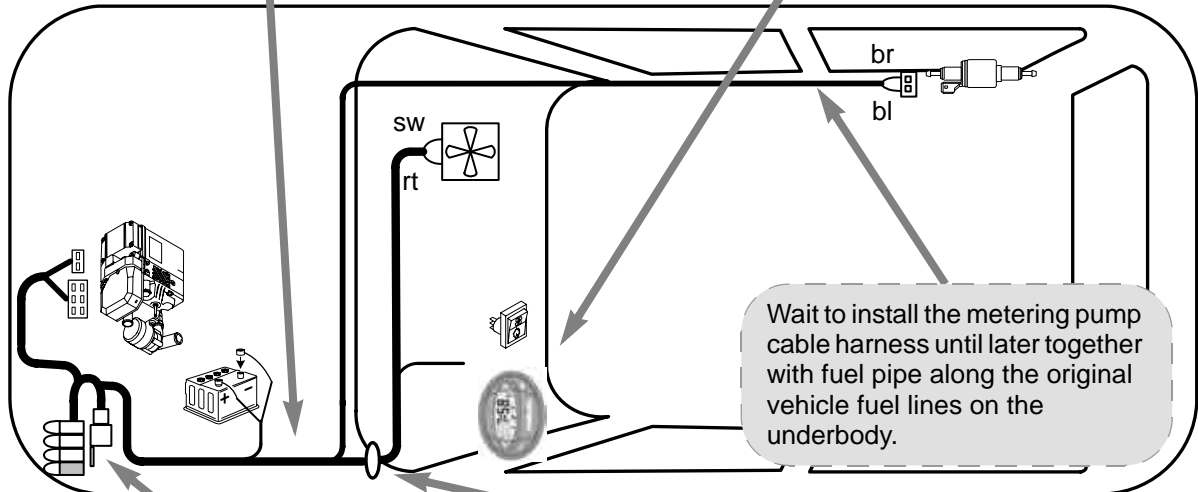
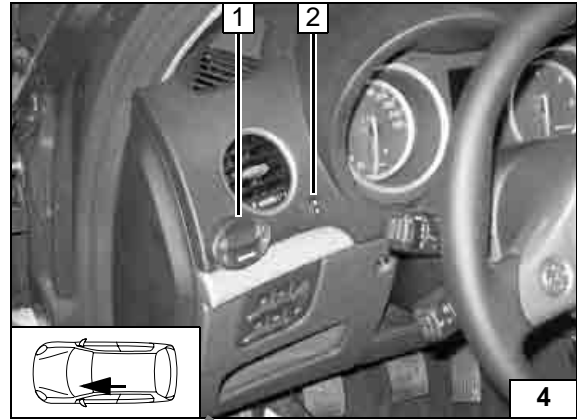

**Cable harness installation diagram**

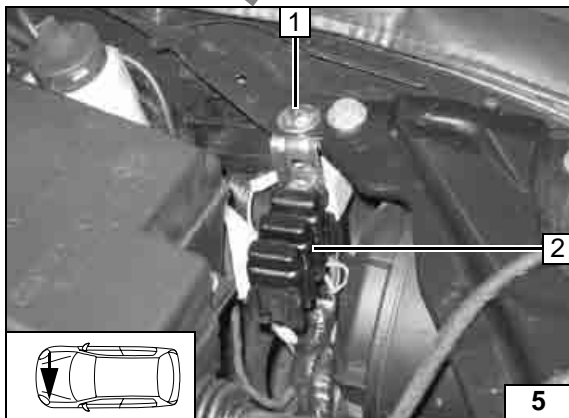

**Fuse holder, K3 relay**

1 Bolt M6x20, washer, original vehicle bore hole, pre-assembled angle bracket, flanged nut M6  
2 Pre-assembled angle bracket with fuse holder K3 relay

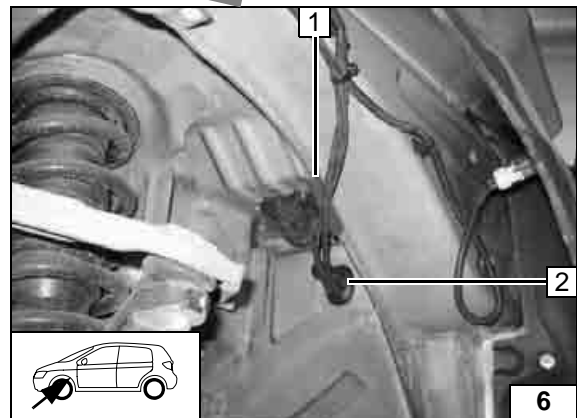

**Cable harness feed-through**

1 Edge protection 50 long  
2 Protective rubber sleeve

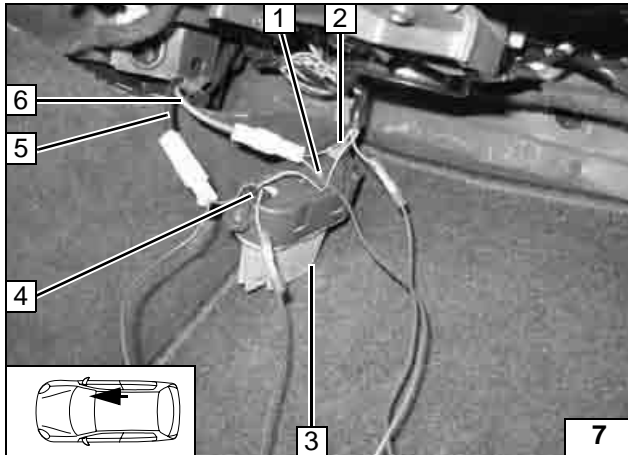

## Automatic air conditioning blower control

Connection to connector A 3-pin 4 from the blower controller. Remove the blower controller 3 for this. This must be completely assembled before initialization. Connect with blade receptacles and butt connectors according to the circuit diagram.

- 1 Red (rt) wire from IPCU/15
- 2 Yellow/black (ge/sw) wire from the air conditioning control K1
- 5 Black (sw) wire from K3/30
- 6 Red (rt) wire to K3/87a

**Connecting the blower controller**

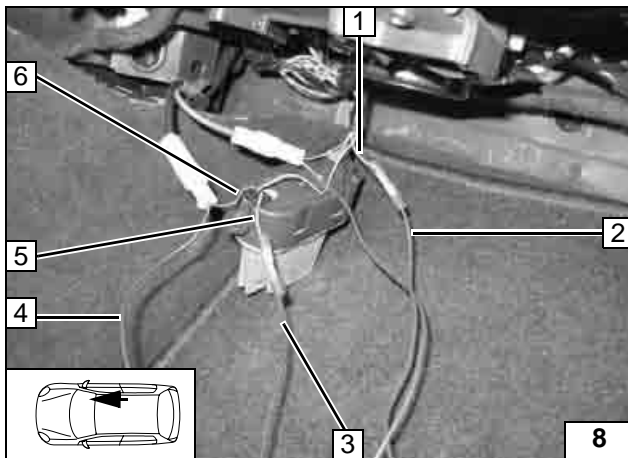

- 1 White/black (ws/sw) wire from the air conditioning control pin17
- 2 Red (rt) wire from IPCU/E
- 3 Black (sw) wire from IPCU/A
- 4 Black (sw) wire from IPCU/86
- 5 White/black (ws/sw) wire from connector A pin3 blower controller
- 6 Yellow/black (ge/sw) wire to connector A pin 1 blower controller

**Connecting the blower controller**

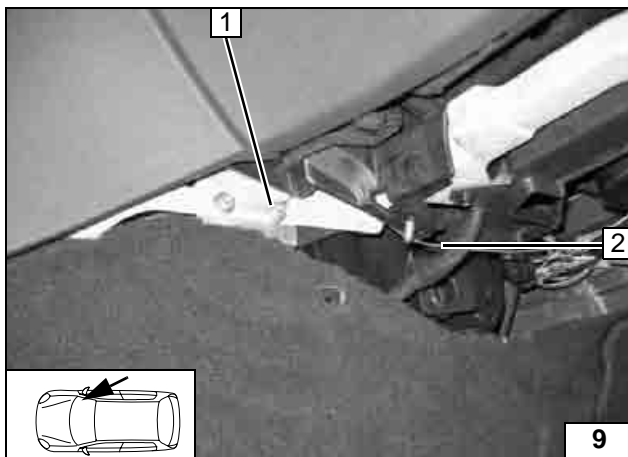

- 1 Cable socket to existing bolt M6
- 2 Brown (bn) wire from IPCU/85

**Connecting the IPCU ground**

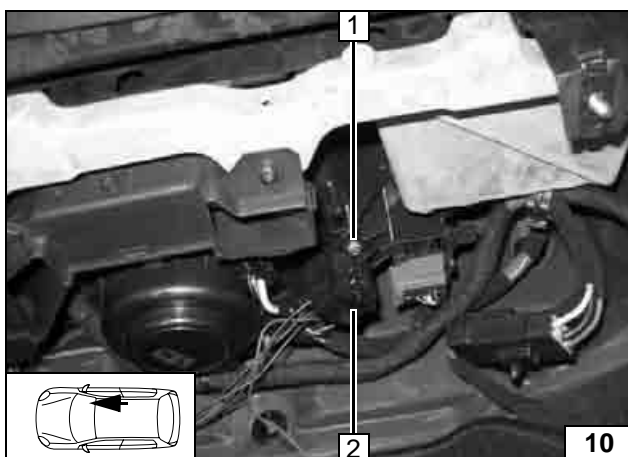

- 1 Original vehicle bolt
- 2 Relay socket for IPCU

**Fastening the relay socket**



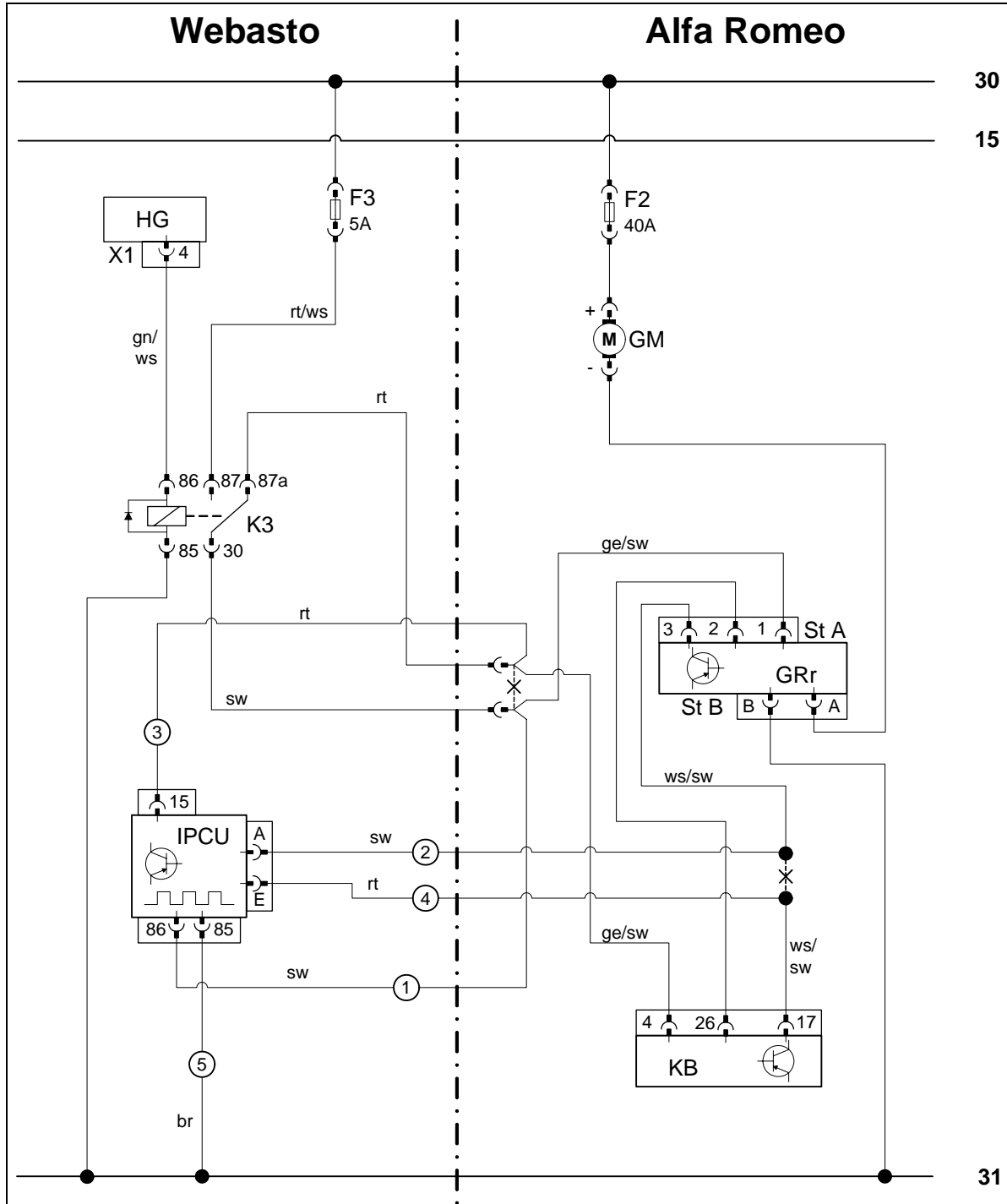

Automatic air conditioning circuit diagram

Webasto components		Components Alfa Romeo 159		Colors and symbols	
HG	Heater unit TT-C/E	GM	Blower motor	rt	red
X1	6-pin connector	GRr	Blower controller	ws	white
F3	Replace fuse 25A with 5A	KB	Air conditioning control	sw	black
K3	Blower relay	KB	Air conditioning control	br	brown
IPCU	Pulse control unit	St A	Connector A on GRr	gn	green
		St B	Connector B on GRr	ge	yellow
<b>Settings IPCU</b>				X	Splitting point
Voltage: 10 V					
Frequency: 100 Hz					
Duty-cycle: 46 %					
Function: Low-side					
				Cable colors may vary.	

Legend

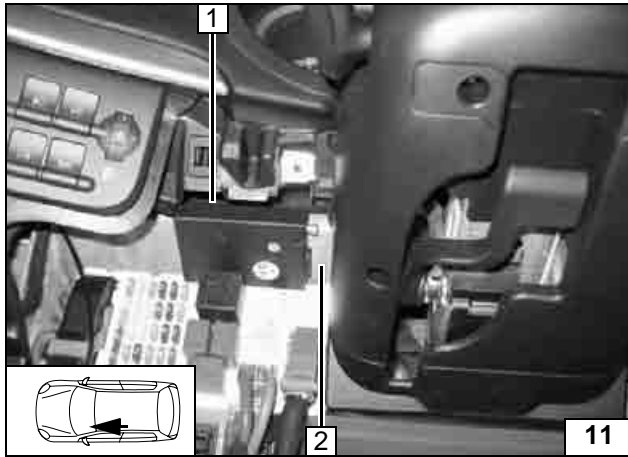

**Remote start option**

- 1 Receiver, double-sided Velcro tape (self adhesive)
- 2 Crossarm below the dashboard on the left



**Assembling the receiver**

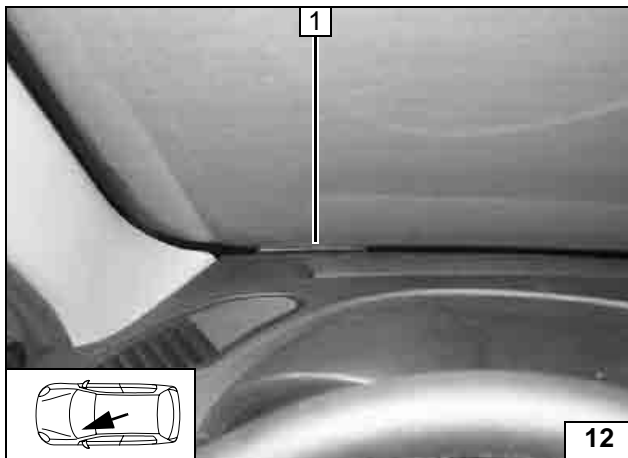

- 1 Antenna

**Assembling the antenna**

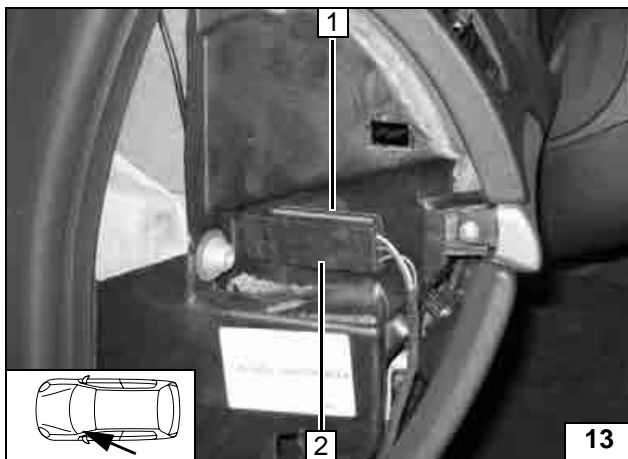

**Temperature sensor for HTM100 only**

- 2 Temperature sensor
- 1 Double-sided Velcro tape (self adhesive)

**Assembling the temperature sensor**

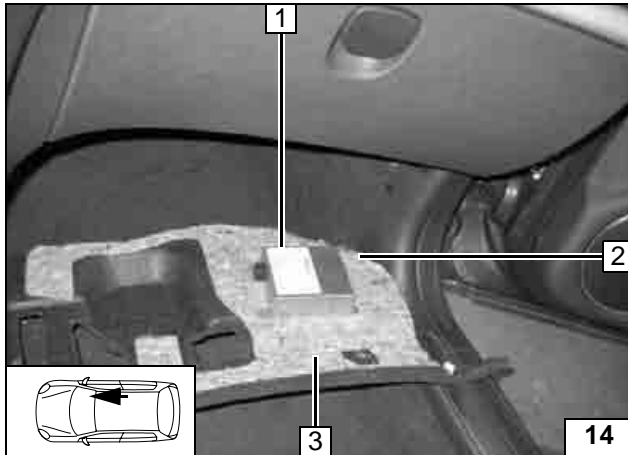

## Thermo Call Option

Cut out the insulation 2 in the receiver 1 area

- 1 Receiver, double-sided Velcro tape (self adhesive) [2x]
- 3 Footwell cover right



**Assembling the receiver**

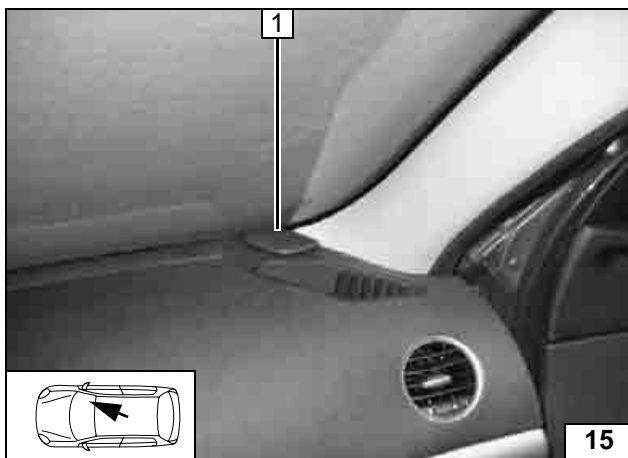

- 1 Antenna

**Assembling the antenna**

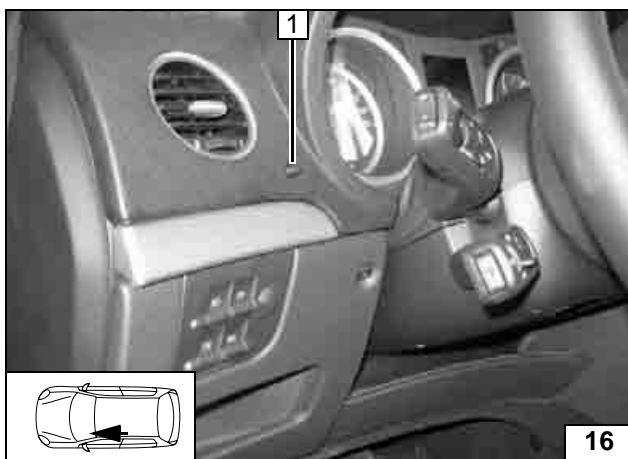

- 1 Tip switch

**Assembling the tip switch**

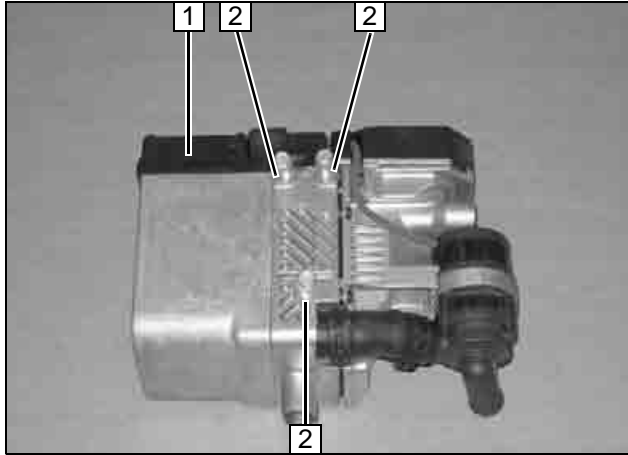
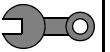

### Preparing the Heater Unit

Pre-cut the thread 2 [3x] in the heater unit 1 with the self-cutting Ejet screw bolts.



Pre-cutting the threads

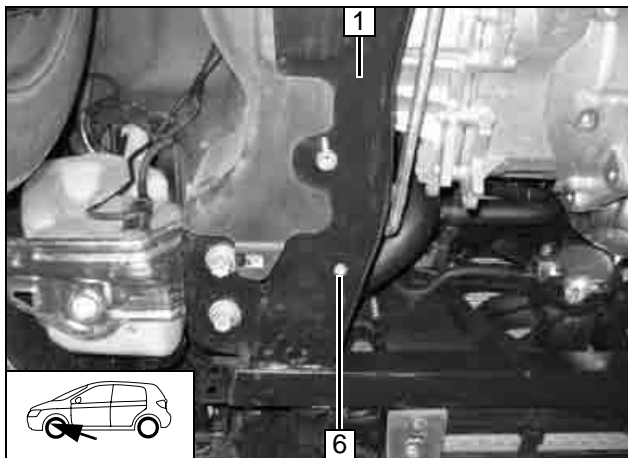

### Preparing the Installation Location

- 1 Original vehicle crossarm
- 2 Rivet nut M6 in available bore hole



Inserting rivet nuts

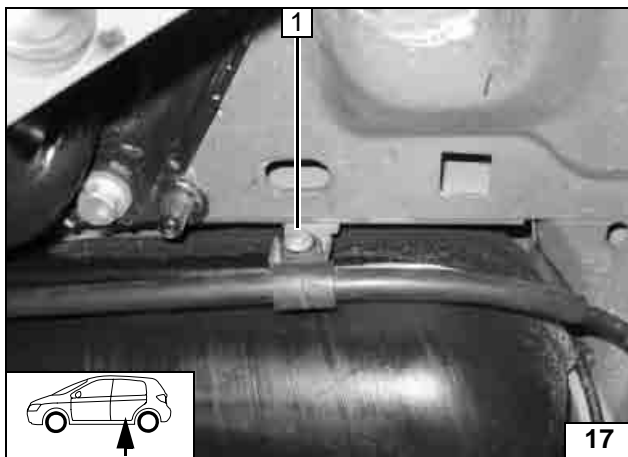

Disassemble the M6 bolt 1 for the hand brake cable. This will be needed to fasten the bracket.



Disassembling the bolts

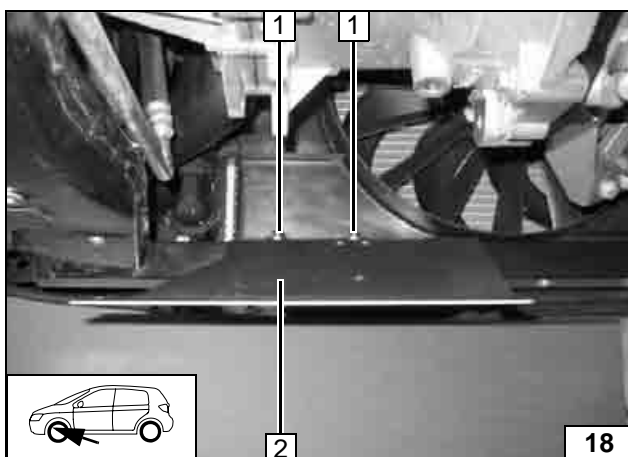

### Assembling the Heater Unit

- 2 Bracket
- 1 Loosely fit the M6x20 bolt [2x], spring washer [2x], body washer [2x], into the existing thread [2x]



Assembling the bracket

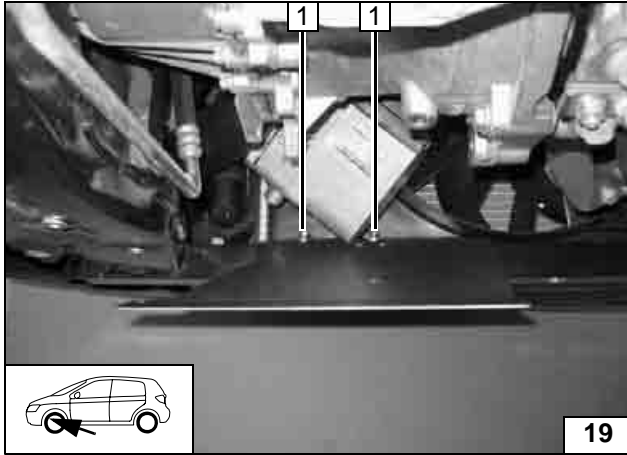
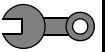

Position the heater unit before completely assembling the bracket and firmly tighten the loosely pre-assembled bolts 1 [2x].



**Assembling the bracket**



Ejot screw bolts tightening torque 10 Nm!  
Insert two washers between the heater unit and the bracket in position 1.



- 1 Ejot screw bolt
- 2 Ejot screw bolt, washer [2x]
- 3 Disassembled M6 bolt from the hand brake cable.

**Pre-assembling the intake silencer**

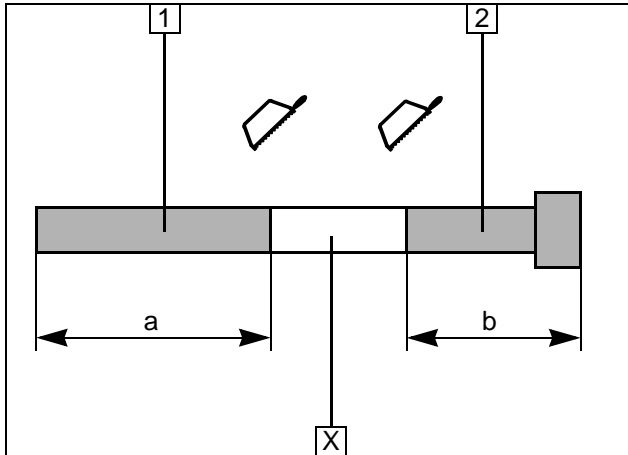

## Exhaust System

- 1 Exhaust pipe  
a = 340mm
- 2 Exhaust end section  
b = 660mm

Dispose of section X

Preparing the exhaust pipe

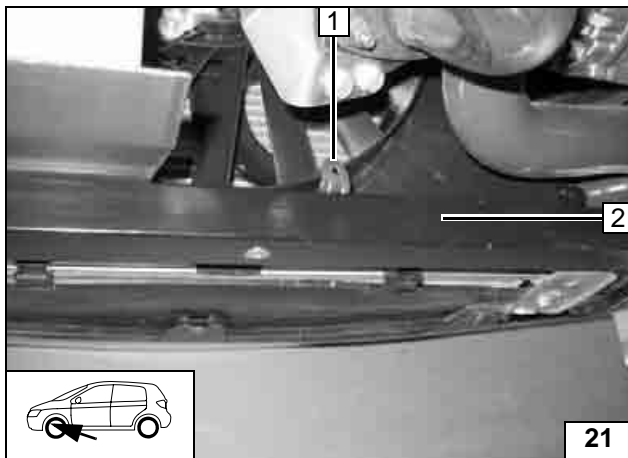

- 1 Angle bracket, M6x20 bolt, spring washer, body washer to existing thread
- 2 Cooler crossarm

Assembling the angle bracket

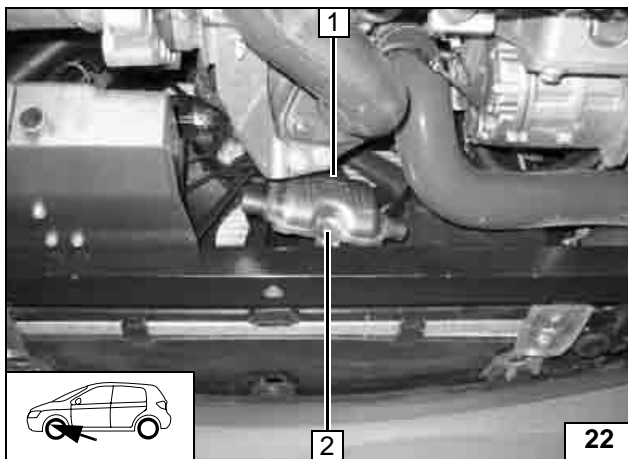

- 1 Exhaust silencer
- 2 M6x20 bolt, flanged nut M6

Assembling the exhaust silencer

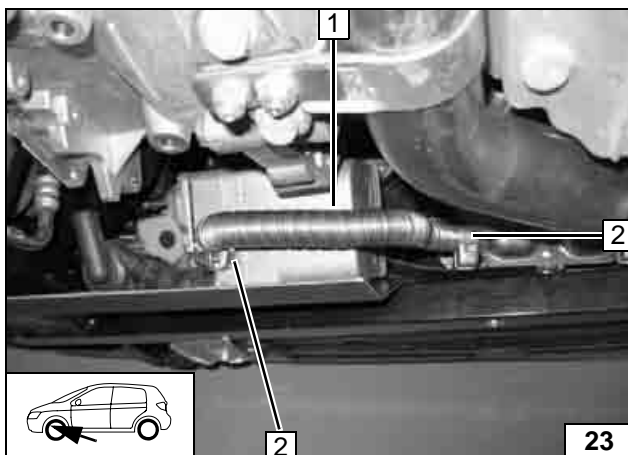

- 1 Exhaust pipe
- 2 Hose clamp [2x]

Assembling the exhaust pipe

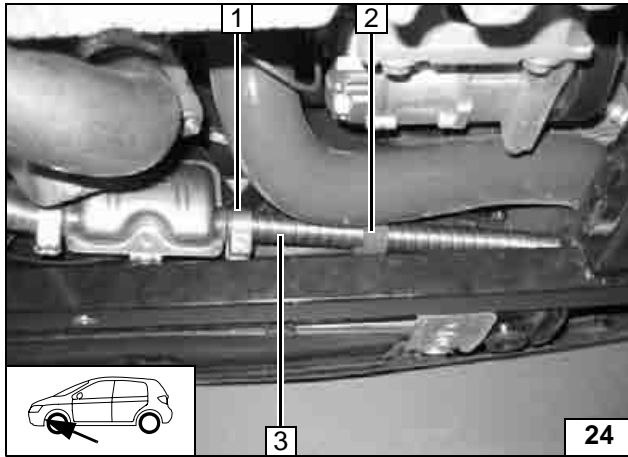

- 3 Exhaust end section
- 1 Hose clamp
- 2 Position red (rt) rubber profile

**Assembling the exhaust end section**

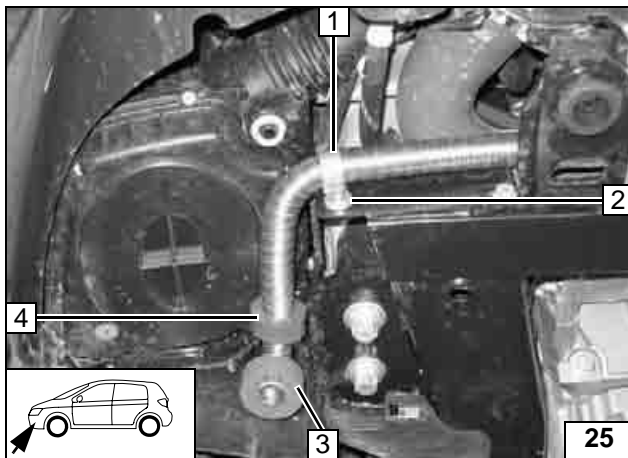

Ensure sufficient distance from adjacent components.

- 1 Tube clamp
- 2 M6x20 bolt, 5mm spacer, body washer, flanged nut M6
- 3 Red (rt) rubber profile with groove
- 4 Red (rt) rubber profile



**Positioning rubber profile**

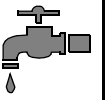

## Water Connection for Gasoline Engines

### WARNING!

Tighten all hose clamps with  $2.0 + 0.5$  Nm.

Any coolant running off should be collected using an appropriate container.

Install hoses so that they are kink-free. Unless specified otherwise, always fasten using cable clips.

Position hose clamps and spring band clamps so that no other hose can be damaged.

The connection should be "inline" based on the following diagram:

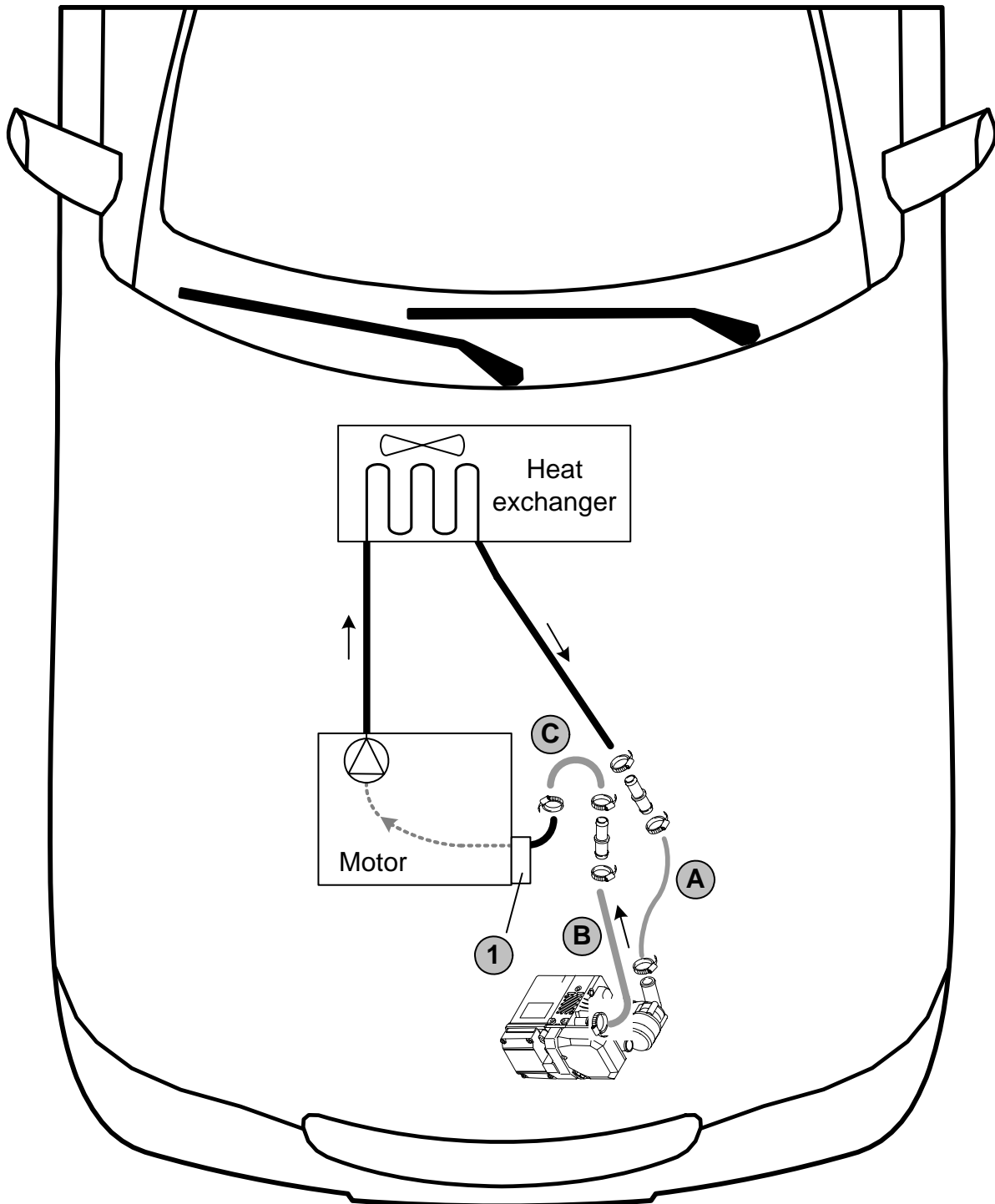

Water  
installation  
diagram

All undesignated clamps are  $\varnothing$  20-27mm hose clamps. Number 1 is the motor oil heat exchanger. All connecting pipes =  $\varnothing$  18x20.





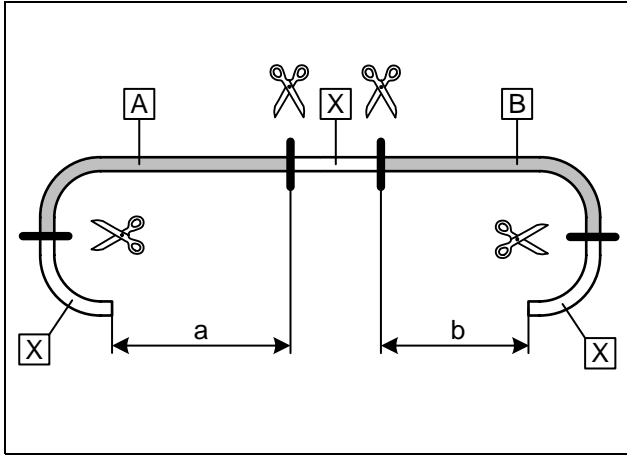

a = 260mm  
b = 290mm

Dispose of section X

Cutting water hoses into sections

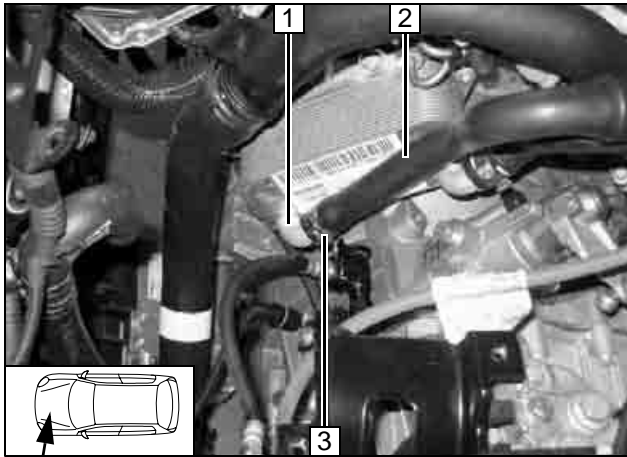

- 1 Engine inlet connecting piece (motor oil heat exchanger)
- 2 Pull off heat exchanger inlet hose (heater)
- 3 Dispose of clamps

Splitting point

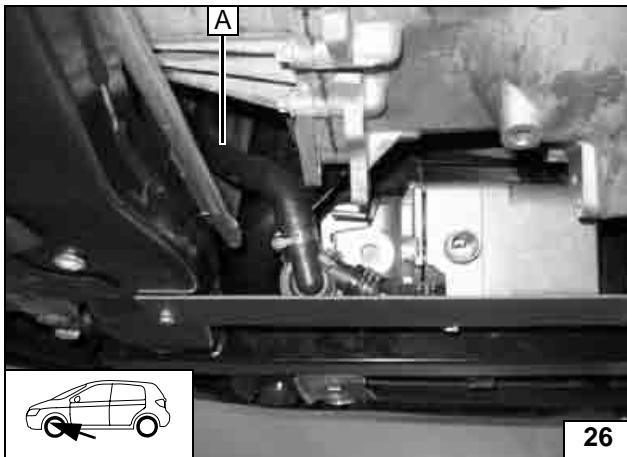

Put hose A with 90° bend on the heater unit inlet.



Connecting to the heater unit

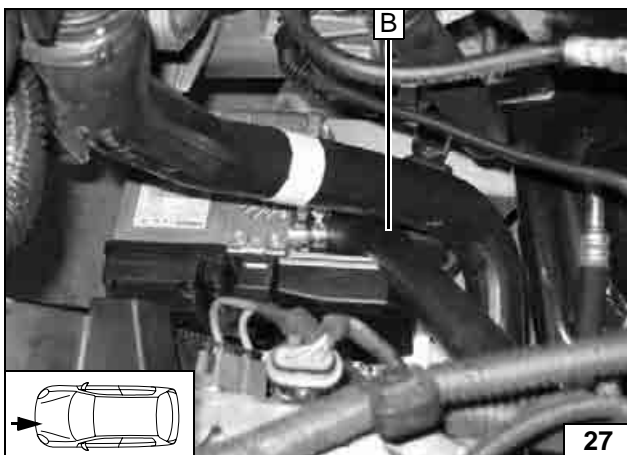

Put hose A with 90° bend on the heater unit outlet.



Connecting to the heater unit

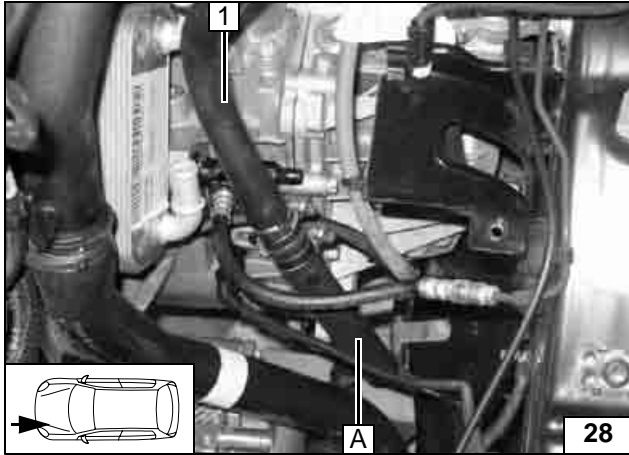

1 Heat exchanger outlet hose

Con-  
necting to the  
heat  
exchanger  
outlet

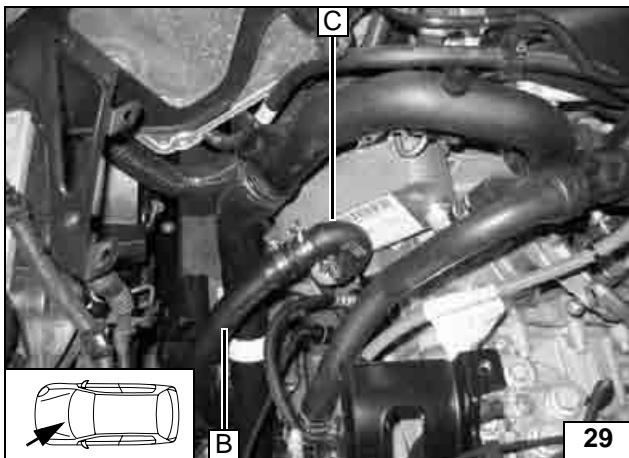

Before connecting, fill the water hoses with coolant.



Con-  
necting to the  
engine  
inlet

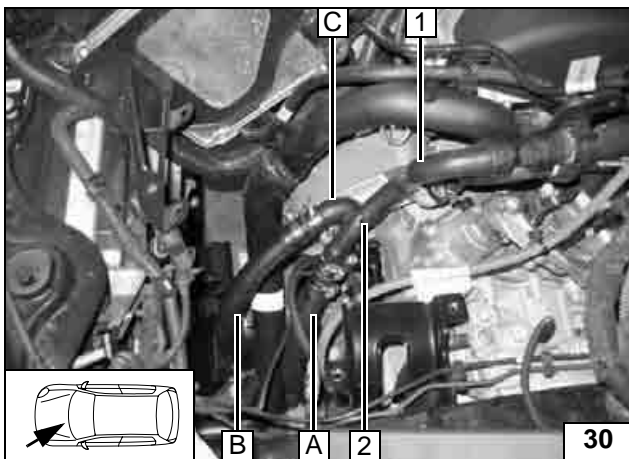

1 Heat exchanger outlet hose  
2 Cable clip

Place-  
ment  
in the  
engine  
compart-  
ment



## Water connection for Diesel Engines

### WARNING!

Tighten all hose clamps with  $2.0 + 0.5$  Nm.

Any coolant running off should be collected using an appropriate container.

Install hoses so that they are kink-free. Unless specified otherwise, always fasten using cable clips.

Position hose clamps and spring band clamps so that no other hose can be damaged.

The connection should be "inline" based on the following diagram:

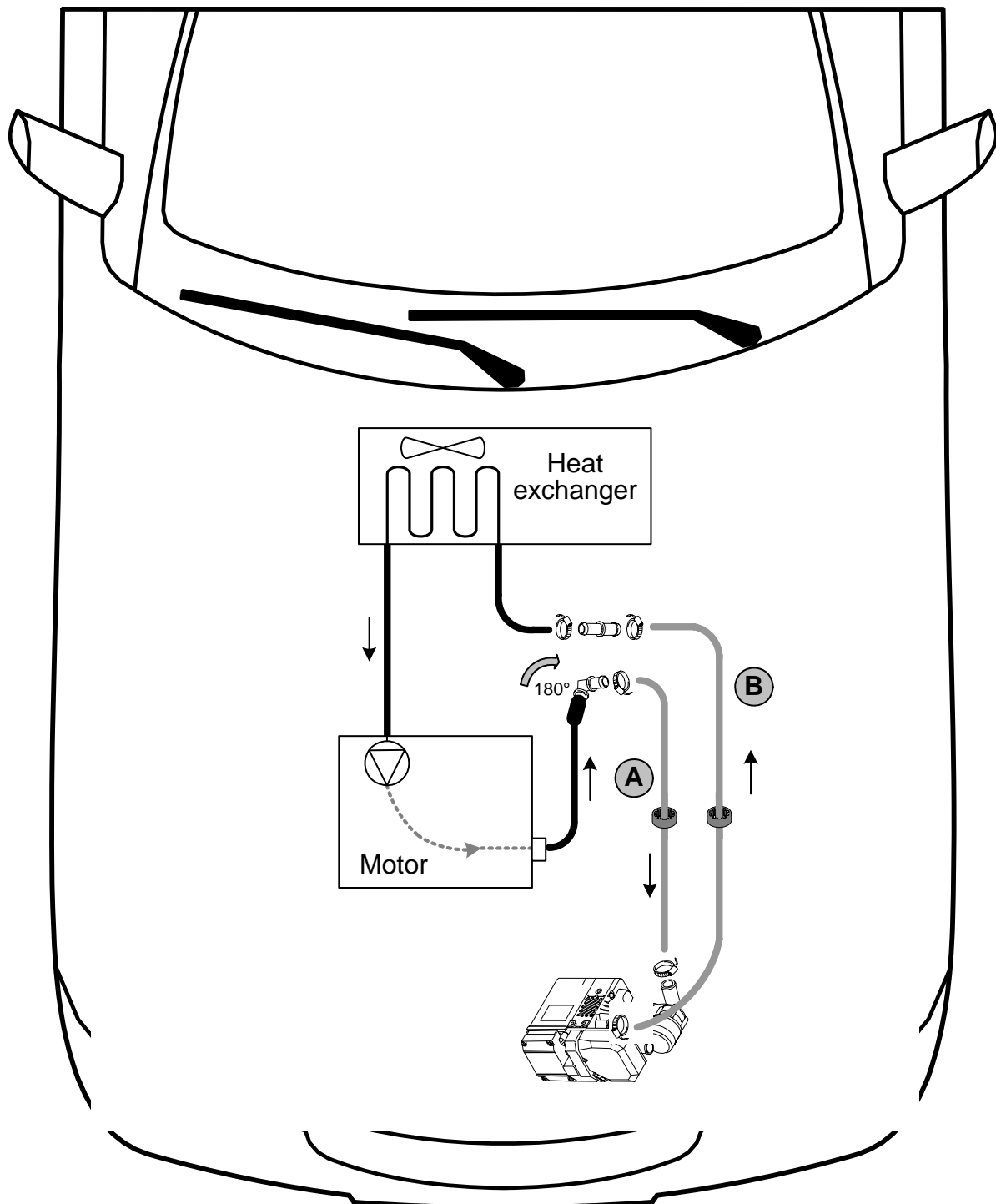

Water installation diagram

All undesiganted clamps are  $\text{Ø } 20\text{-}27\text{mm}$  hose clamps.  
All connecting pipes =  $\text{Ø } 20\text{x}20$ .



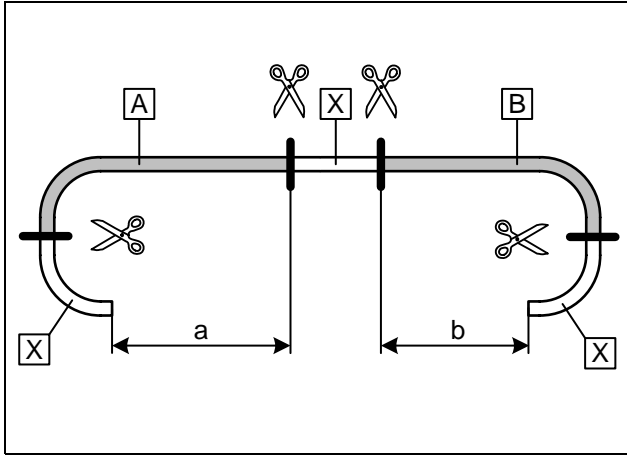

a = 650mm  
b = 720mm

Dispose of section X

**Cutting  
water  
hoses into  
sections**

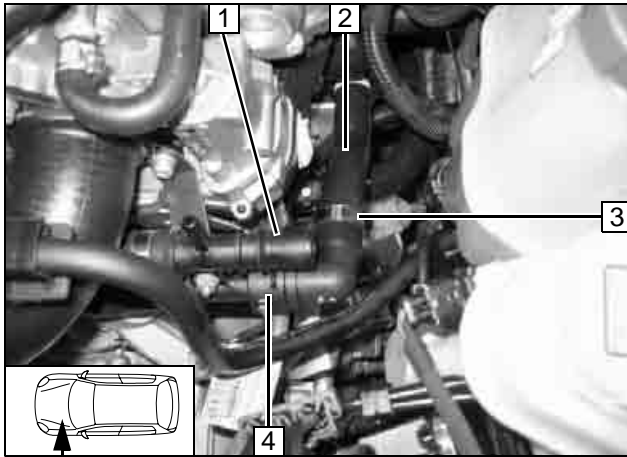

For a better illustration, the heat exchanger outlet hose connection from the connecting piece 1 has been pulled off.

- 2 Loosen the original vehicle hose to the heat exchanger inlet from the connecting piece.
- 3 Dispose of clamps
- 4 Turn the original vehicle connecting piece from the engine outlet by 180°.

**Splitting  
point**

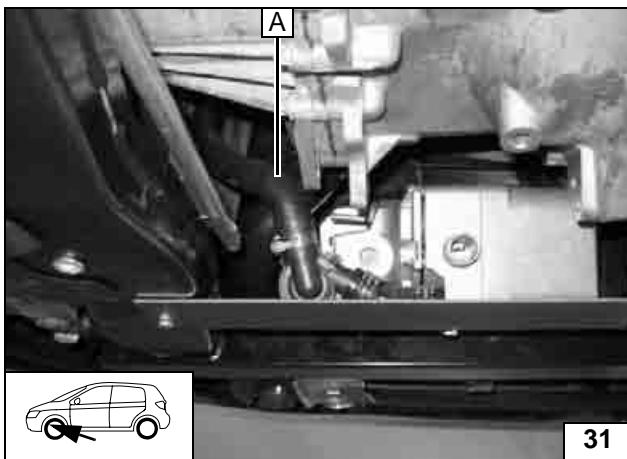

Put hose A with straight end on the heater unit inlet.



**Connec-  
ting to the  
heater unit**

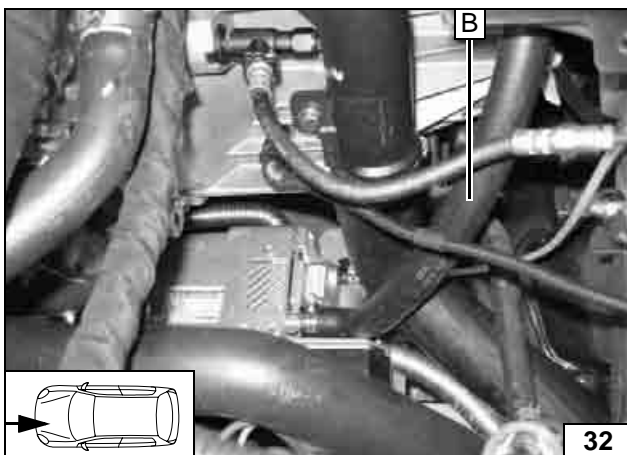

Put hose A with 90° bend on the heater unit outlet.



**Connec-  
ting to the  
heater unit**

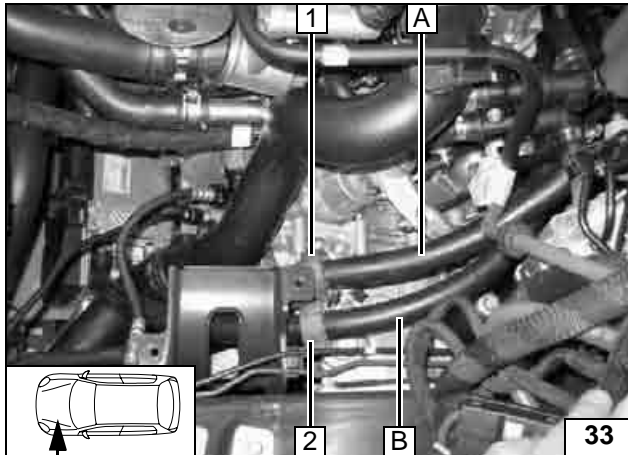

Position the black (sw) rubber profile **1** and **2** on the hose **A** and use the cable harness to fasten this to the ground point on the gears.

**1** Ø 27 mm hose clamp



**Installing in the engine compartment**

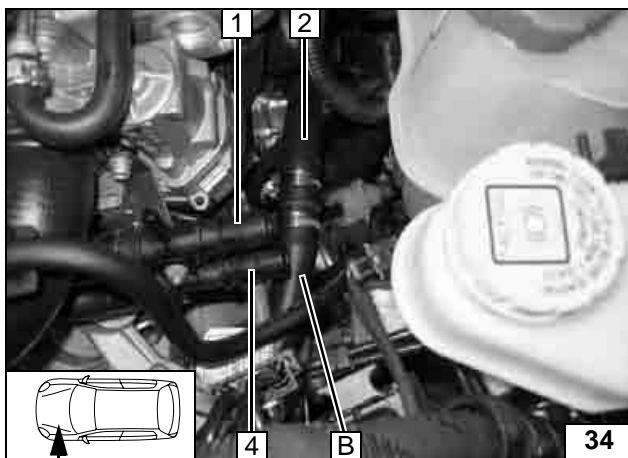

For a better illustration, the hose connections from the connecting pieces **1** and **3** have been pulled off.

**2** Heat exchanger inlet hose

**Connecting to the heat exchanger inlet**

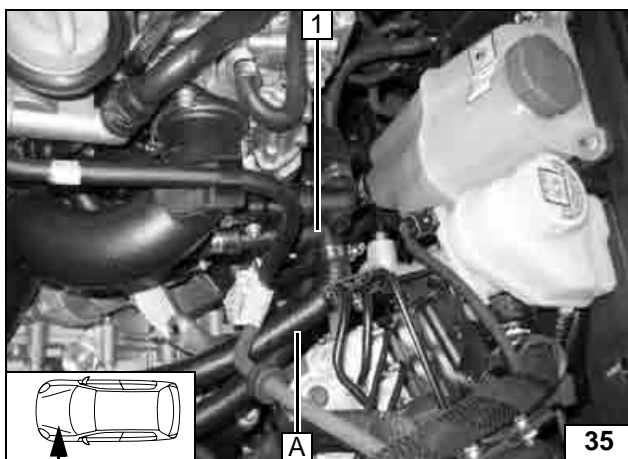

Before connecting, fill the water hoses with coolant.

**1** Engine outlet connecting piece turned 180°



**Connecting to the engine outlet**

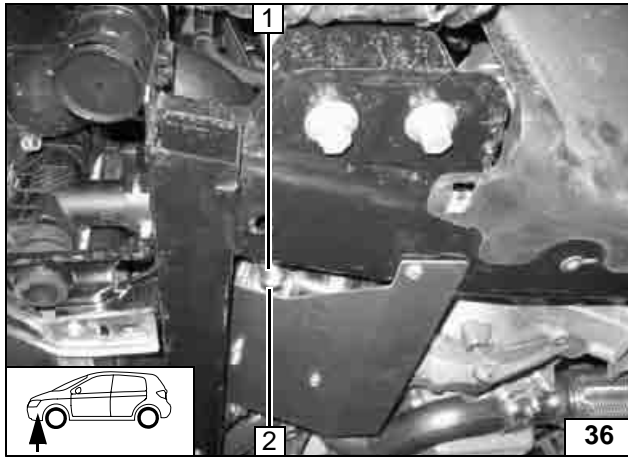
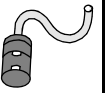

## Combustion Air

- 1 Combustion air intake pipe
- 2 Ø 27 mm hose clamp



**Assembling the vacuum line**

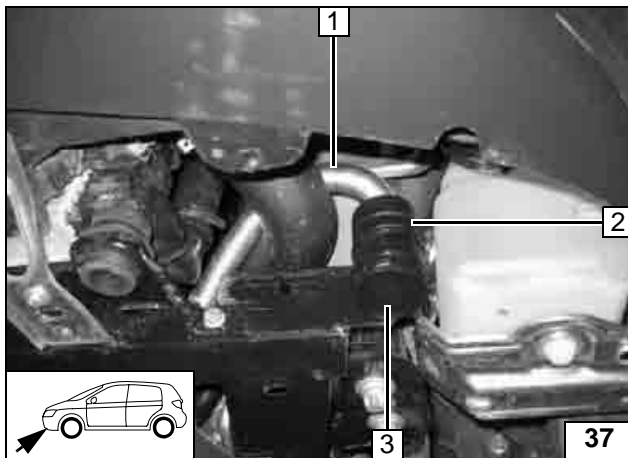

- 1 Combustion air intake pipe
- 2 Cable clip
- 3 Combustion air intake silencer on the available bore hole

**Assembling the silencer**



**Fuel Connection**

**CAUTION!**

Open the vehicle's tank-cap lock, ventilate the tank and then re-close the tank lock.

Catch any fuel running off with an appropriate container.

Install fuel line and metering pump cable harness so that they are protected against stone impact. Unless specified otherwise, always fasten using cable clips.

Fit the fuel line and cable harness with edge protectors around sharp edges.

**WARNING!**

The fuel line and cable harness to the metering pump should be installed based on the cable harness installation diagram.

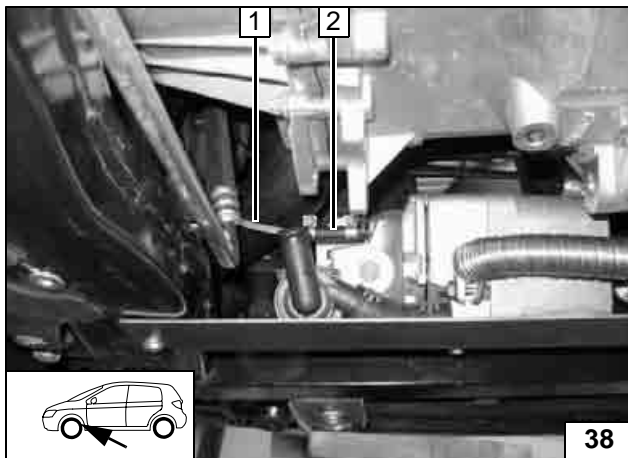

**For All Vehicles**

- 1 Mecanyl fuel line
- 2 Hose section, Ø 10 mm hose clamps [2x]

**Connec-  
ting to the  
heater unit**

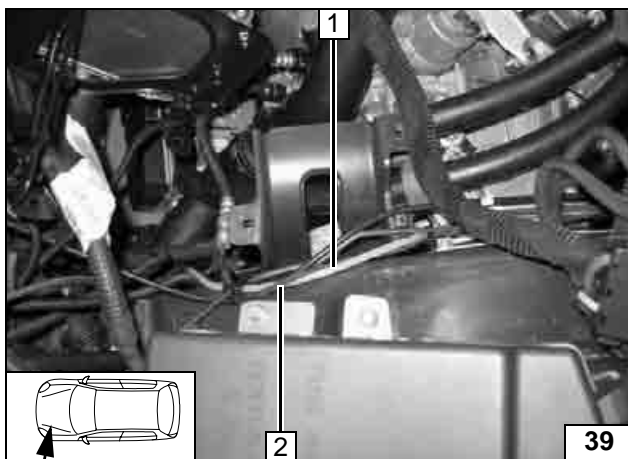

Install the Mecanyl fuel pipe 1 and the metering pump cable harness 2 on the original vehicle brake line on the right side of the vehicle.

**Installing  
wires**

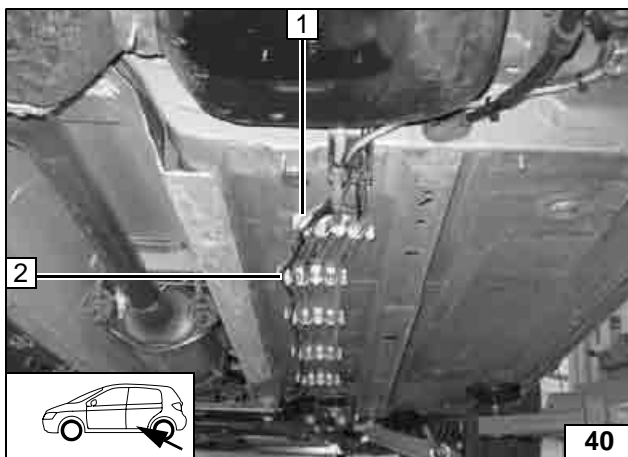

Install the Mecanyl fuel pipe 1 and the metering pump cable harness 2 on the original vehicle fuel lines to the metering pump installation location.

**Installing  
wires**

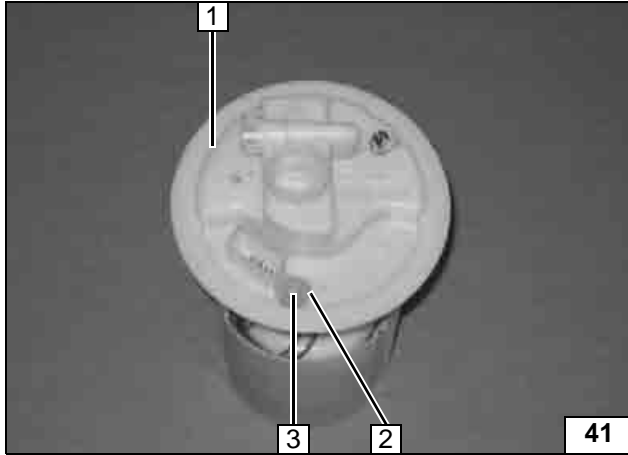

**Only for gasoline vehicles**

Remove tank mounting according to manufacturer's instructions.

- 1 Tank mounting
- 2 Washer, external Ø =17.6mm
- 3 Copy the hole image, Ø6mm bore hole



**Copy the hole image**

Catch any bore shavings.

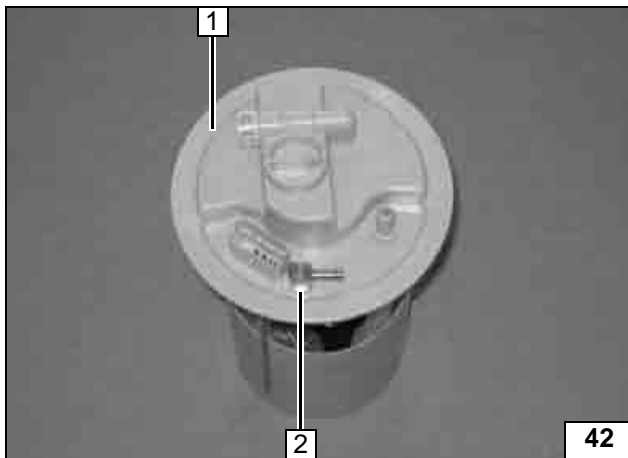

Shape, cut into sections, and insert the tank extracting device according to the template, see the Installation Instructions.

- 1 Tank mounting
- 2 Tank extracting device



**Inserting tank extracting device**



**Inserting tank extracting device**

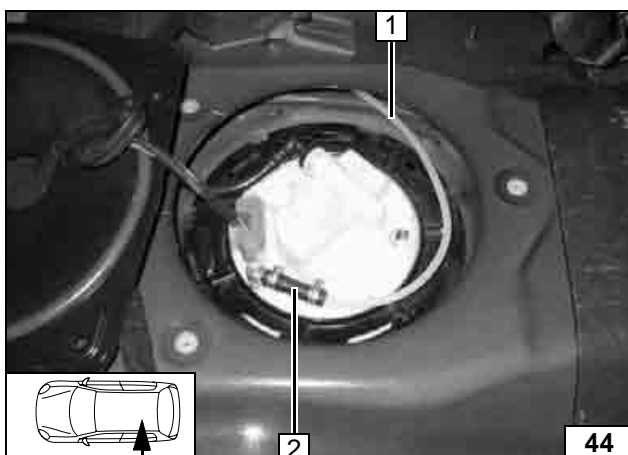

Install the tank mounting according to manufacturer's instructions.

- 1 Residual section of Mecanyl fuel line
- 2 Hose section, Ø 10 mm hose clamps [2x]



**Connecting the fuel line**



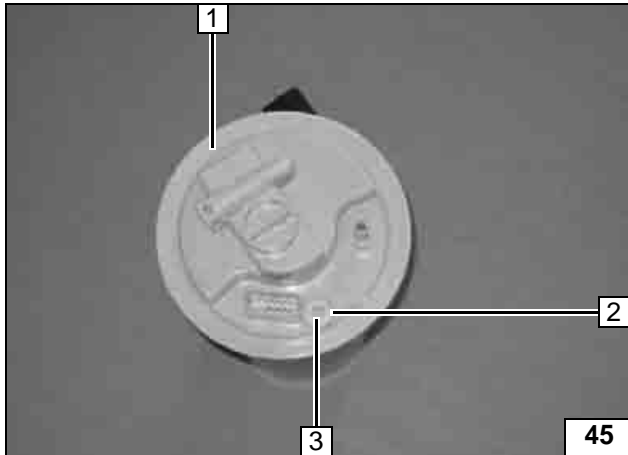

45

### Only for diesel vehicles

Remove tank mounting according to manufacturer's instructions.

- 1 tank mounting
- 2 Washer, external  $\varnothing = 17.6$  mm
- 3 Copy the hole image,  $\varnothing 6$  mm bore hole



Copy the hole image

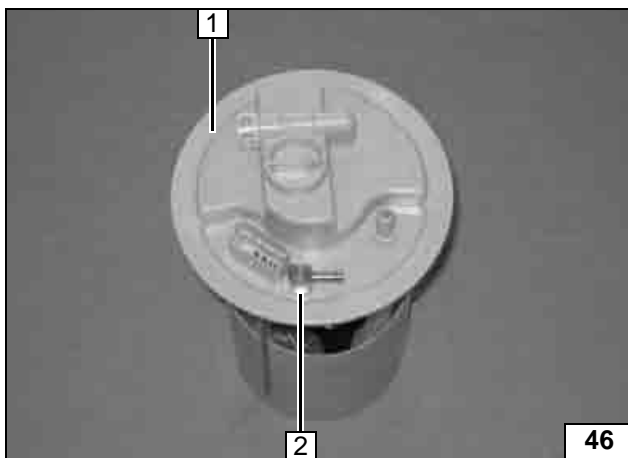

46

Catch any bore shavings.

Shape, cut into sections, and insert the tank extracting device according to the template, see the Installation Instructions.

- 1 Tank mounting
- 2 Tank extracting device



Inserting tank extracting device



47

Inserting tank extracting device

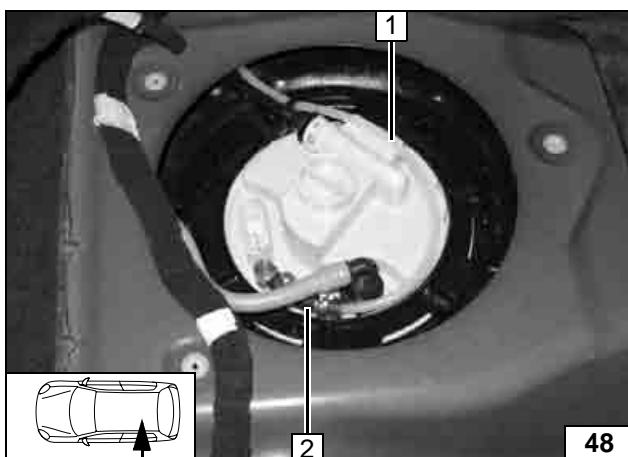

48

Install the tank mounting according to manufacturer's instructions.

- 1 Residual section of Mecanyl fuel line
- 2 Hose section,  $\varnothing 10$  mm hose clamps [2x]



Connecting the fuel line

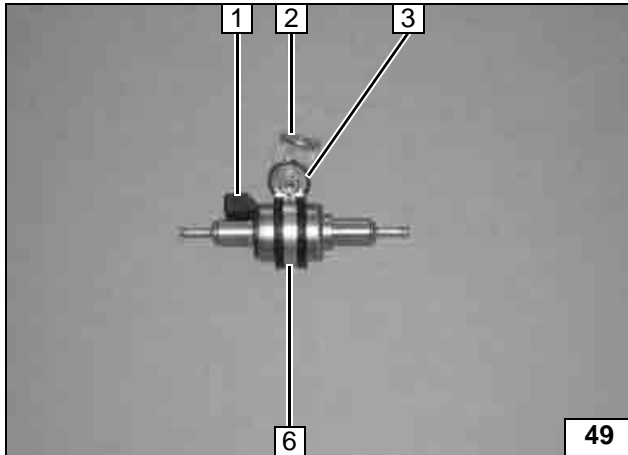

### For All Vehicles

- 1 Metering pump
- 2 Angle bracket
- 3 Silentblock, flanged nut [2x]
- 4 Rubberized tube clamp



### Pre-assembling the metering pump

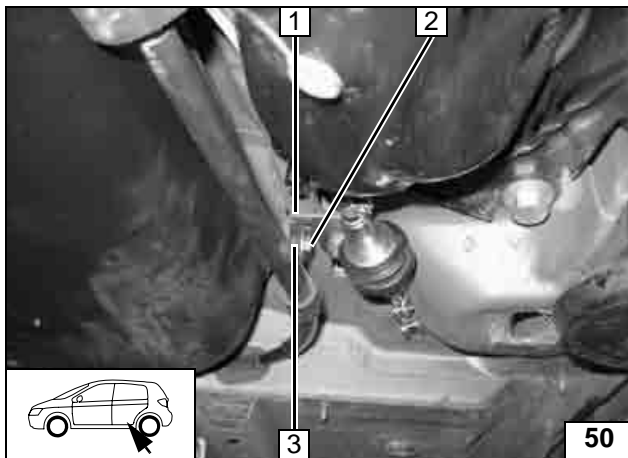

- 1 Angle bracket
- 3 Hand brake cable clamps
- 2 M6x20 bolt, body washer in existing thread



### Assembling the metering pump

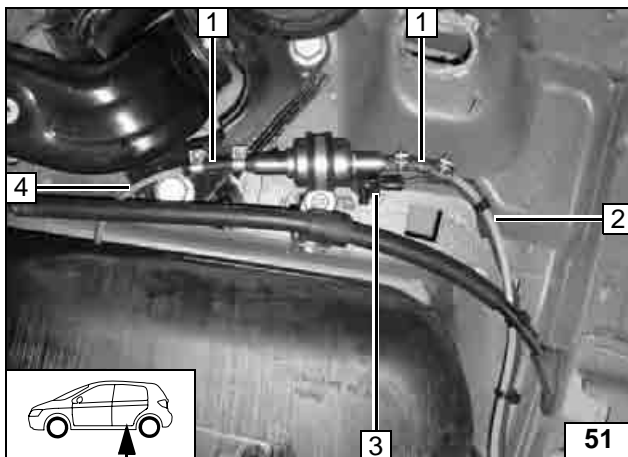

Fuel line from the tank extracting device on the intake side of the metering pump [side without connector].  
Check the position of the components; adjust if necessary. Check that these rotate freely.

- 1 Hose sections [2x], Ø 10 mm hose clamps [4x]
- 2 Fuel pipe and metering pump cable
- 3 Metering pump cable harness connector
- 4 Residual section of Mecanyl fuel line



### Connecting to the metering pump

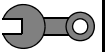

**Final Work**

**WARNING!**

Reassemble disassembled components in reverse order. Check that all hose lines, hose clips, and all electrical connections are securely fastened. Secure all loose lines using cable clip. Only use manufacturer-approved coolant. Spray heating unit components with anti-corrosion wax (Tectyl 100K, Order No. 111329).

- Connect battery. Start engine, bleed coolant circuit according to the manufacturer's specifications, fill up with coolant.
- Set the time switch.
- Make settings according to "Operating instructions for the end customer".
- Check that the auxiliary heating operates properly, see operating instructions / installation instructions.
- Attach the "Switch off auxiliary heating before re-fuelling" sticker onto the left side of the B-pillar.

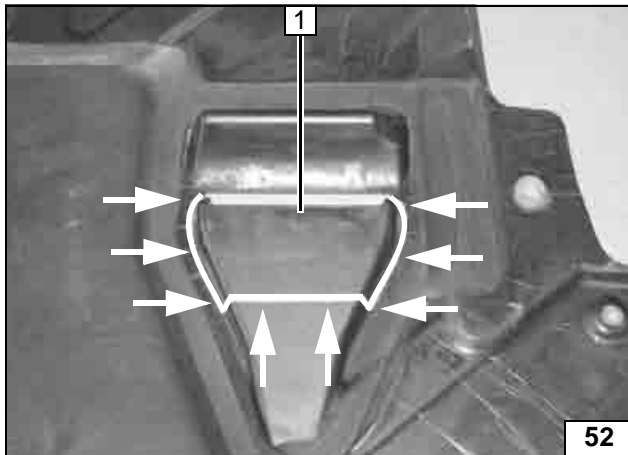

**For gasoline vehicles only**

Cut out the fresh air opening on the indicated line and dispose of section 1.

**Cut out the under-ride protection**

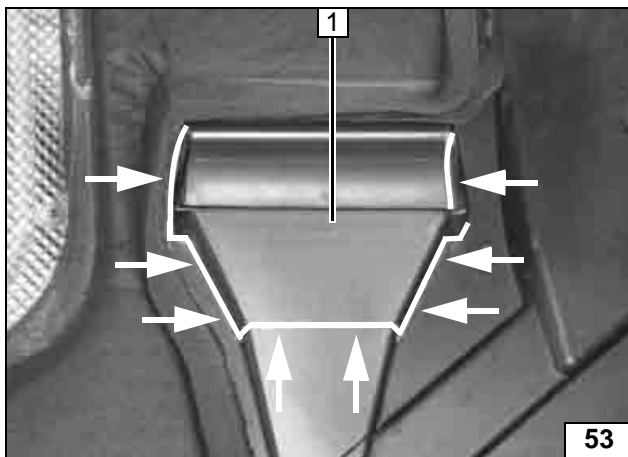

**For diesel vehicles only**

Cut out the fresh air opening on the indicated line and dispose of section 1.

**Cut out the under-ride protection**

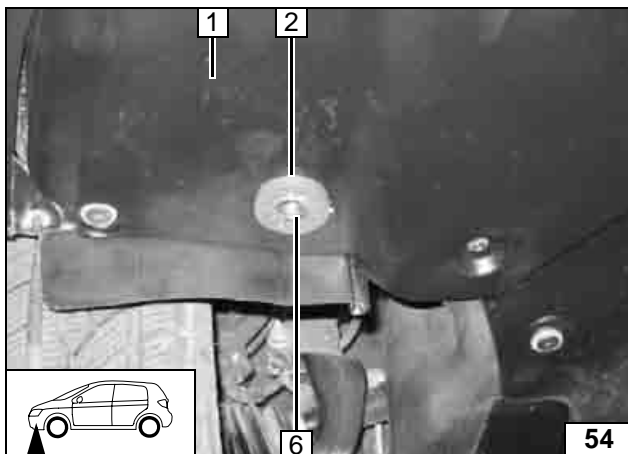

**For All Vehicles**

Insert the red (rt) rubber profile with groove 2 in the under-ride protection 1. Align the end cap from the exhaust end section 3 flush with the red (rt) rubber profile 3 according to the illustration.



**Inserting rubber profile**

## Operating instructions for the end customer

Please remove page and add to the vehicle operating instructions.



Before parking the vehicle, make the following settings:

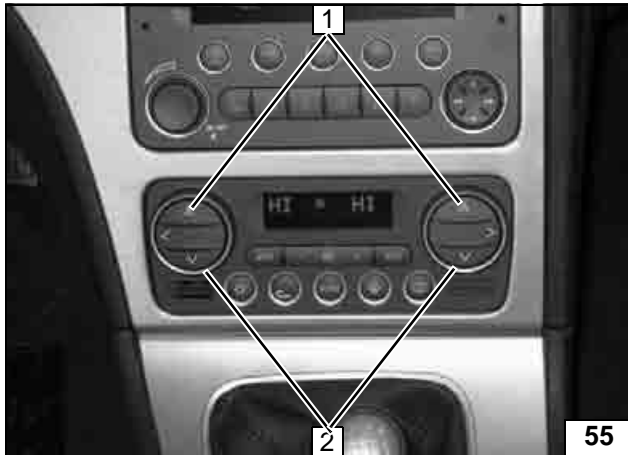

- 1 Air outlet to windscreen
- 2 Temperature to "HI"

For vehicles with automatic air conditioning

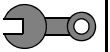

### Tank extracting device template

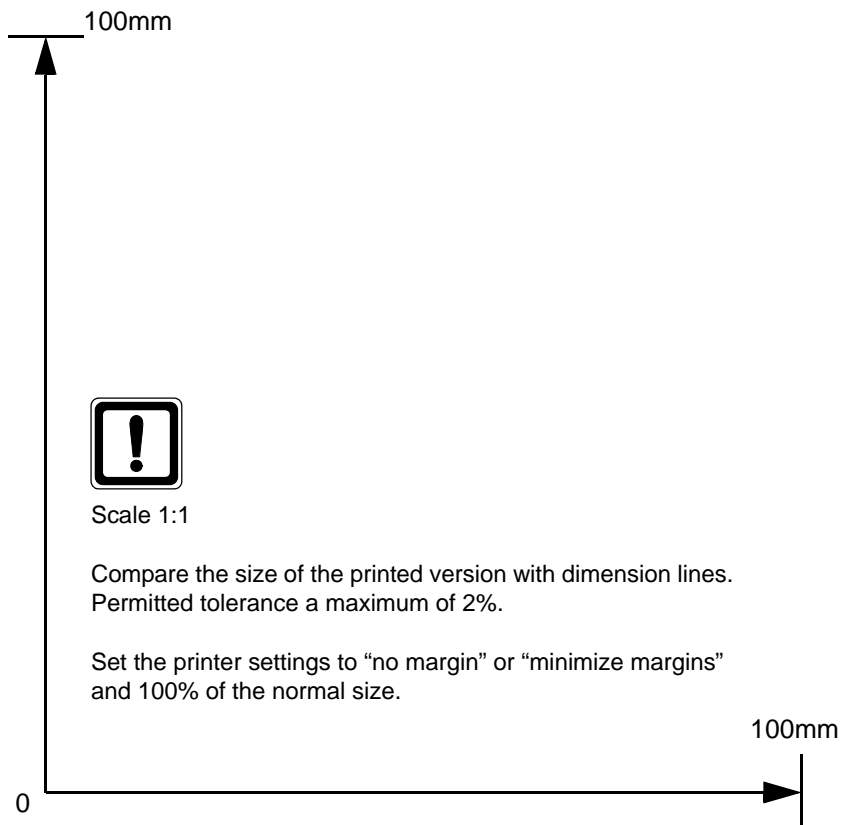



*Feel the drive*

Webasto AG  
Postfach 80 - 82132 Stockdorf - Hotline 0 18 05 / 93 22 78  
Hotfax (0395) 55 92-353 - <http://www.webasto.de>